

Instruction Manual
for
Ultrasonic Level Meter

Model: NUS-4...



1. Contents

1. Contents.....	2
2. Note	4
3. Instrument Inspection.....	4
4. Regulation Use.....	4
5. Operating Principle.....	5
6. Mechanical connection.....	5
6.1 Block distance.....	5
6.2 Installation (Liquid Level Measurement)	6
6.3 Installation (Open Channel Flow Measurement).....	7
6.4 Mechanical connection	8
7. Electrical Connection	8
8. Programming	9
8.1 BASIC CONCEPTS AND ELEMENTS OF THE ULTRASONIC MEASUREMENT	9
8.2 Programming without Display Module.....	9
8.3 Programming with the Display Module NUS-400P	11
8.3.1 Display Module NUS-400P	12
8.3.2 Programming steps with the Display Module NUS-400P	13
8.3.3 GET LEVEL Function	14
8.3.4 INDICATIONS OF THE NUS-400P AND LED STATUS	14
8.3.5 QUICKSET	15
8.3.6 Full Parameter Access.....	17
9. Parameters – Description and Programming	18
9.1 Measurement Configuration.....	18
9.2 Current Output.....	21
9.3 Relay Output.....	22
9.4 Measurement Optimisation	23
9.5 Volume Measurement.....	26
9.6 Volume Flow Measuring	27
9.7 32- Point Linearisation	31
9.8 Informational Parameters (Read Out Parameters)	32
9.9 Additional Parameters of Flow Metering in Open Channels.....	33
9.10 Test Parameters	33
9.11 Simulation	33
9.12 Access Lock.....	34
10. Error Codes.....	34
11. Parameter Table	35
12. Sound Velocities in Different Gases.....	36
13. Technical Data	37
14. Order Codes	38
15. Dimensions	39
16. EU Declaration of Conformance.....	40

Manufactured and marketed by:

Kobold Messring GmbH
Nordring 22-24
D-65719 Hofheim
Tel.: 06192-2990
Fax: 06192-23398
Internet: <http://www.kobold.com>
e-mail: info.de@kobold.com

2. Note

Please read these operating instructions before unpacking and putting the unit into operation. Follow the instructions precisely as described herein. The devices are only to be used, maintained and serviced by persons familiar with these operating instructions and in accordance with local regulations applying to Health & Safety and prevention of accidents.

When used in machines, the NUS should be used only when the machines fulfil the EC-machine guidelines.

3. Instrument Inspection

Instruments are inspected before shipping and sent out in perfect condition. Should damage to a device be visible, we recommend a thorough inspection of the delivery packaging. In case of damage, please inform your parcel service / forwarding agent immediately, since they are responsible for damages during transit.

Scope of delivery:

The standard delivery includes:

- Ultrasonic level meter model: NUS-4
- Instruction Manual

4. Regulation Use

Model NUS-4 is a compact user friendly ultrasonic level meter comprising of an ultrasonic sensor and an integrated evaluating electronics. It was specifically developed for level and volume measurement in open and closed vessels or for flow measurement in open channels.

Level measurement technology based on the non-contacting ultrasonic principle is especially suited for applications where, for any reason, no physical contact can be established to the surface of the material to be measured.

Such reasons may include corrosive attack by the process medium against the measuring device material (acids), possible contamination (sewage) or particles of the process medium adhering to the measuring device (adhesive materials).

5. Operating Principle

The sensor emits an ultrasonic pulse train and receives the echoes reflected. The intelligent electronic device processes the received signal by selecting the echo reflected by the surface and calculates from the time of flight the distance between the sensor and the surface. A Norm signal output is available for remote transfer whereas a relay contact is available for monitoring purpose.

A narrow beam angle ensures a reliable measurement in narrow silos with uneven side walls as well as in process tanks with various protruding objects. Furthermore, as a result of the narrow beam angle - the emitted ultrasonic signals have an outstanding focusing - deep penetration through gases, vapour and foam is ensured.

6. Mechanical connection

6.1 Block distance

Due to signal characteristics of the sensor, there is an area directly below the sensor, where no pulses can be received (Dead Zone).

The so called Block distance (minimum measuring distance) is very important for error free functioning of the level meter. It determines the minimal distance between the sensor and maximum level. This distance can be extended by programming in order to avoid disturbing effects of possible disturbing echoes coming from fixed objects (Close-end Blocking).

- Mount the sensor high enough that even with maximum filling of the container, the block distance is not violated. Violation of the block distance may lead to device-malfunction.

Model	Block distance
NUS-4x04	0,20 m
NUS-4x06	0,25 m
NUS-4x08	0,35 m
NUS-4x10	0,35 m
NUS-4x15	0,45 m
NUS-4x25	0,60 m

6.2 Installation (Liquid Level Measurement)

- Never mount two ultrasonic level-measuring devices in one container, because the two devices can interfere with each other's functioning.

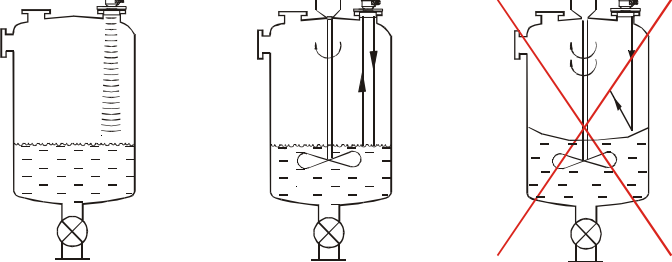
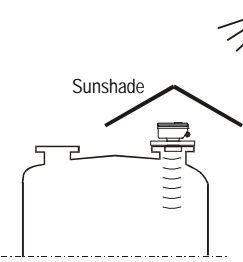
<p>POSITION</p> <p>The optimal position of the NUS-4 is on the radius $r = (0.3 \dots 0.5) R$ of the (cylindrical) tank / silo. (Take also sonic cone on page 39 into consideration.)</p>	
<p>SENSOR ALIGNMENT</p> <p>The sensor face has to be parallel to the surface of the liquid within $\pm 2-3^\circ$.</p>	<p>TEMPERATURE</p> <p>Make sure that the transmitter will be protected against overheating by direct sunshine.</p> 
<p>OBSTACLES</p> <p>Make sure that no inflow path or objects (e.g. cooling pipes, ladders, bracing members, thermometers, etc.) or no tank wall of the ragged surface protrude into the sensing cone of the ultrasonic beam. One fix object in the tank / silo that disturb the measurement can be blocked out by the optional programming unit.</p>	<p>FOAM</p> <p>Foaming of the liquid surface may render ultrasonic level metering impossible. If possible, a location should be found, where foaming is the least (device should be located as far as possible from liquid inflow) or a stilling pipe or well should be used.</p> <p>WIND</p> <p>An intensive air (gas) movement in the vicinity of the ultrasonic cone is to be avoided. A strong draft of wind may "blow away" the ultrasound. Devices with lower measuring frequency (40, 20 kHz) are recommended.</p> <p>FUMES / VAPOURS</p> <p>For closed tanks containing chemicals or other liquids, which creates fume/gases above the liquid surface especially for outdoor tanks exposed to the sun, a strong reduction of the nominal measuring range of the ultrasonic device is to be considered during device selection. Devices with lower measuring frequency (40, 20 kHz) are recommended in these cases units.</p>

STAND-OFF PIPE

The structure of the stand off pipe should be rigid; the inner rim where the ultrasonic beam leaves the pipe should be rounded.

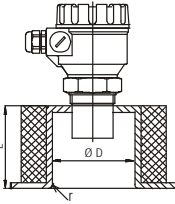
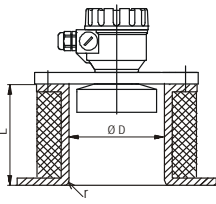
	L	Dmin				L	Dmin		
		NUS-4x04	NUS-4x06	NUS-4x08			NUS-4x10	NUS-4x15	NUS-4x25*
	150	50	60	60		90	80	130	-
	200	50	60	75		200	80	140	-
	250	65	65	90		350	85	150	-
	300	80	75	105		500	90	160	-
	350	95	85	120					

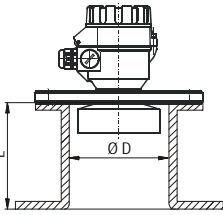
	L	Dmin	
		NUS-4x10	NUS-4x15
	90	80	130
	200	80	140
	350	85	150
	500	90	160

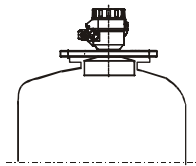

*NUS-4x25

must not be mounted on a pipe socket, since the sensor surface should protrude into the vessel

6.3 Installation (Open Channel Flow Measurement)

- For ultimate accuracy, install the sensor as close as possible above the expected maximum water level (see minimum measuring range).
- Install the device in a place defined by the characteristics of the metering channel along the longitudinal axis of the flume or weir.
- In some cases foam may develop on the surface. Make sure that the surface, opposite to the sensor remains free of foam for proper sound reflection.
- From the point of view of measurement accuracy the length of the channel sections preceding and following the measuring flume and their method of joining to the measuring channel section are of critical importance.
- Despite of the most careful installation, the accuracy of flow metering will be lower than that of specified for the distance measurement. It will be determined by the features of the flume or weir applied.

6.4 Mechanical connection

- Screw the unit in to its place. Use open wrench for tightening; max torque is 20Nm
- After tightening the enclosure can be rotated to the proper position. (Safety bolt prevents rotation more than 350°)

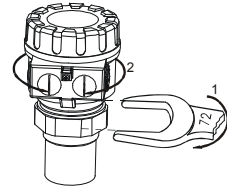

7. Electrical Connection

- Ensure that the power supply is turned off at the source.
- The unit may be damaged by electrostatic discharge (EDS) via its terminal, thus apply the precautions commonly used to avoid electrostatic discharge e.g. by touching a properly grounded point before removing the cover of the enclosure.
- With removal of the cover of the housing and taking out the display module (if any), the screw terminals can be accessed. Suggested cable core cross section: 0.5 ... 1.5 mm². Arrange grounding by the inner or outer grounding screw first.
- Switch on the unit and make necessary programming.
- The actual loop current can be measured with an accuracy of 0.5% by connecting a voltmeter (in the range of 200 mV) to the points indicated on the drawing
- After programming ensure proper sealing and closing of the cover.

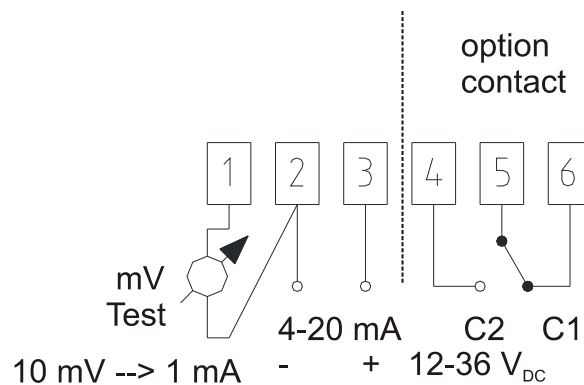

8. Programming

8.1 BASIC CONCEPTS AND ELEMENTS OF THE ULTRASONIC MEASUREMENT

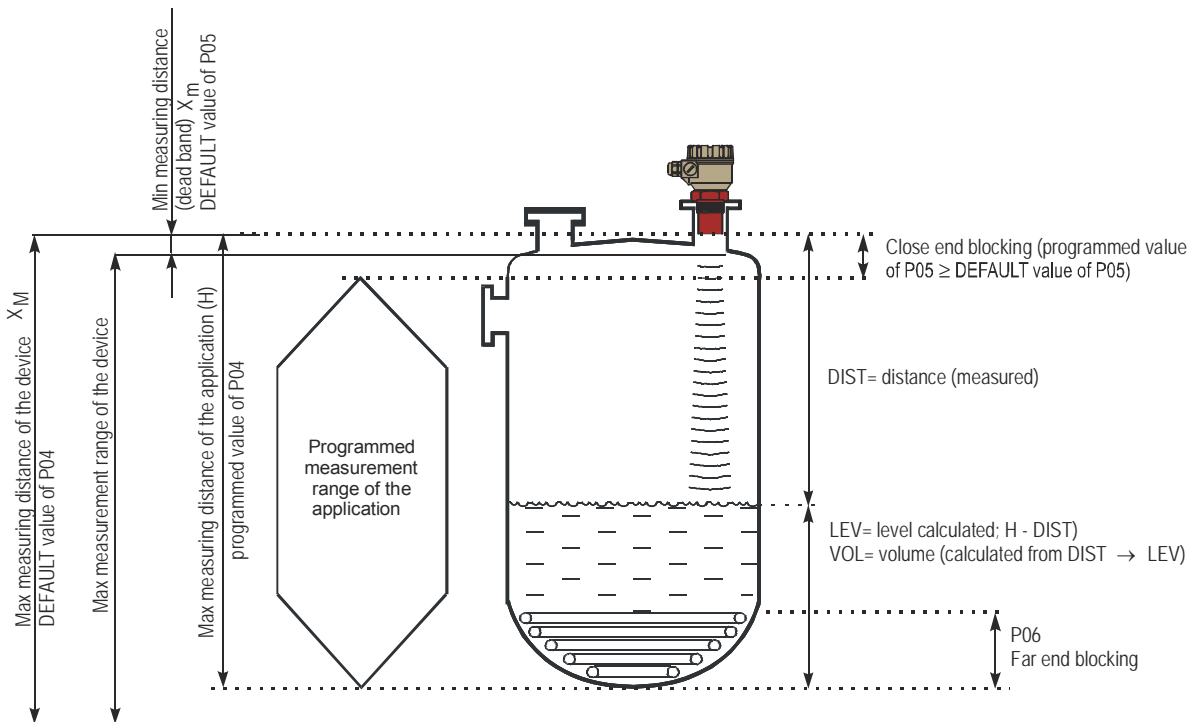

8.2 Programming without Display Module

Programming is only possible if the Transmitter is in Level Measuring Mode and receives valid echo i.e. "VALID" LED is lit!

The following can be programmed without display module

- Assignment of the 4 mA to a required e.g. min. level / max. distance
- Assignment of the 20 mA to a required e.g. max. level / min. distance
- Error indication by the current output (Hold, 3.6 mA or 22 mA)
- Damping (10, 30 or 60 sec)
- Reset to the factory default

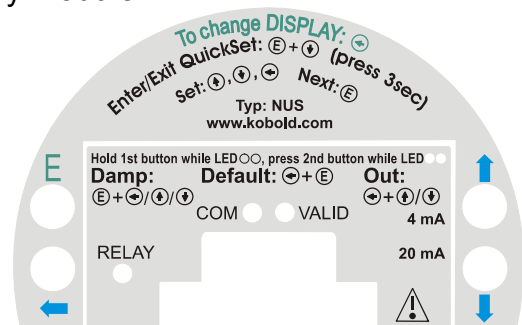

Note:
Current output can also be assigned in inverted mode:
4 mA = 100 % (Full), 20 mA = 0 % (Empty)

NUS-4

Procedure of programming: press button in the relevant sequence and check the state of the LED-s. Symbols for the states of the LED-s:

○ = LED is off, ● = LED is blinking, ●● = LED is on, ●○ = LEDs are blinking alternatively ⊗ = Dont care

Minimum level, (0%, empty tank) assignment to 4 mA

Place the sensor at a distance to an object corresponding to the maximum distance/ the minimum level.

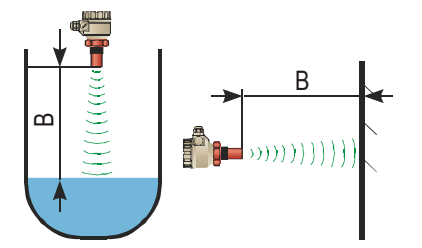
Action	Led state following the action	 <p>Use level in tank or a fix target e.g. the wall</p>
1) Check for a valid ECHO	⊗● = Valid ECHO, transmitter programmable	
2) Press NEXT ⊕ button steadily	○○ = NUS-4 in programming mode	
3) Press UP ⊕ button steadily	●● = 4 mA assigned to the distance (see picture)	
4) Release buttons	○○ = Programming completed	

Maximum Level, (100 %, full tank) assignment to 20 mA

Place the sensor at a distance to an object corresponding to the minimum distance/ the maximum level.

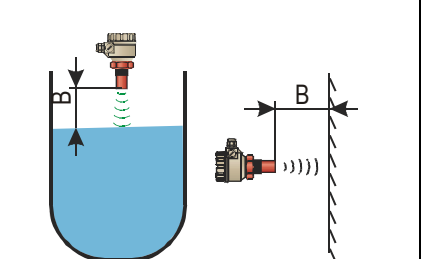
Action	Led state following the action	 <p>Use level in tank or a fix target e.g. the wall</p>
1) Check for a valid ECHO	⊗● = Valid ECHO, transmitter programmable	
2) Press NEXT ⊕ button steadily	○○ = NUS-4 in programming mode	
3) Press DOWN ⊖ button steadily	●● = 20 mA as signed to the distance (see picture)	
4) Release buttons	○○ = Programming completed	

“Error state” indication by the analogue signal (Check for a valid echo as above)

As a result of this setting the value of the analogue output will be 3.8 mA; 22 mA or according last value (hold) until the error is ceased.

Action	Led state following the action
1) Press ⊕ button steadily	○○ = NUS-4 in programming mode
2) Press any of the DOWN ⊖, ENTER ⊕, NEXT ⊕ buttons steadily	<p>– hold last value</p> <p>●● = – 3.6 mA</p> <p>– 22 mA</p>
3) Release buttons	○○ = Programming completed

Damping time setting (Check for a valid echo as above)

Action	Led state following the action
1) Press ENTER $\text{\textcircled{E}}$ button steadily	○○ = NUS-4 in programming mode
2) Press any of the NEXT $\text{\textcircled{+}}$, UP $\text{\textcircled{\u2191}}$, DOWN $\text{\textcircled{\u2193}}$ buttons steadily	●● = – 10 sec – 30 sec – 60 sec
3) Release buttons	○○ = Programming completed

RESET: Returning to the default (Check for a valid echo as above)

Action	Led state following the action
1) Press NEXT $\text{\textcircled{+}}$ button steadily	○○ = NUS-4 in programming mode
2) Press ENTER $\text{\textcircled{E}}$ button steadily	●● = Default loaded

Indication of mistakes (by LEDs) made during programming

Action	Led state following the action	Possible correction
Attempted programming	●● = blinking twice = no Echo	Find a valid Echo
Attempted programming	●● = blinking three times = no access possible	With NUS-400P only See 8.3 (P99)
Attempted programming	●● = blinking four times = NUS-4 not in Level Measurement Mode	With NUS-400P only See 8.3 (P01)

8.3 Programming with the Display Module NUS-400P

All features of the unit can be set, such as measurement configuration and optimisation, 32-point linearisation, dimensions for 11 tanks with different shape and for 21 different open channels (flume, weir, etc).

Devices with the type number NUS-xxxx xx xxP are already equipped with the display module.

The NUS-4 is also fully operational without display module. The module is only needed for programming and/or displaying measurement values.

The unit will measure during programming in accordance with the previous parameters. The new, modified parameters will only be effective after returning to the Measurement Mode

If the transmitter is left in Programming Mode by mistake, it will automatically return to Measurement Mode after 30 minutes and will operate with the parameters entered during the last completed programming.

NUS-4

The NUS-4 will be delivered with the following Factory Default:

- Current output, display and bargraph: LEVEL
- Current output and bargraph proportional to the level
- 4 mA: assigned to the minimum level 0 %
- 20 mA: assigned to the maximum level 100 %
- Error indication by the current output: hold last value
- Damping: 60 sec

The display module supports two separately accessible programming modes representing 2-layers of programming complexity, depending on user choice.

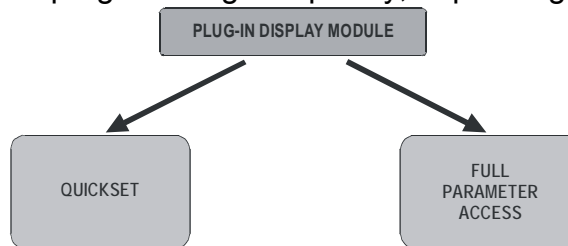

8.3.1 Display Module NUS-400P

Symbols used on the LCD:

- **DIST** – Distance (measuring) mode
- **LEV** – Level (measuring) mode
- **VOL** – Volume (measuring) mode
- **FLOW** – Open channel (flow metering) mode
- **PROG** - Programming mode (device under programming)
- **RELAY** – ‘C2’ circuit of the relay is closed
- **T1** - TOT1 volume flow totaliser (resettable aggregate)
- **T2** - TOT2 volume flow totaliser (aggregate)
- **FAIL** - Measurement / device error
- **↑ ↓** - Level changing direction

Bargraph assigned to the current output or echo strength

Symbols used on the frame:

- **M** – Metric system
- **US** – US calculation system

LEDs lit

- **VALID** – presence of valid echo

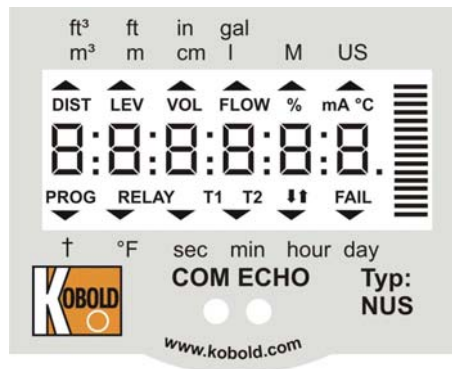

8.3.2 Programming steps with the Display Module NUS-400P

Programming will be performed by the pressing and releasing the relevant one or two keys (simultaneously).

Single key pressing

ENTER (E) to select parameter address and go to parameter value
to save parameter value and return to parameter address

NEXT (N) to move the blinking (sign of change) of the digit to the left

UP (U) to increase value of the blinking digit

DOWN (D) to decrease value of the blinking digit

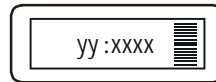

yy parameter address (P01, P02...P99)
xxxx parameter value (dcba)
bargraph

Double key pressing

Press the two keys simultaneously for desired programming step.

Enter into or quit programming modes

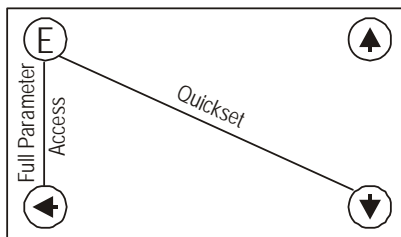

Basic steps while parameter address is blinking

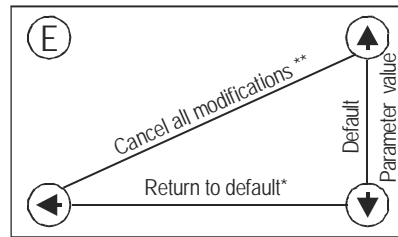

* LOAD readout ** CANCEL readout

Basic steps while parameter value is blinking

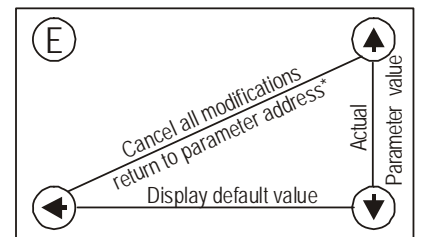

* cancellation immediately active

8.3.3 GET LEVEL Function

Special function used only in level and distance measurement modes

UP \uparrow + DOWN \downarrow

Notes:

If after pressing ENTER \ominus blinking does not spring over from the parameter address to the parameter value this means that

- the parameter is either a read-out type, or
- the secret code prevents the modification (see P99)

If the modification of the parameter value is not accepted i.e. the parameter value keeps blinking after pressing ENTER \ominus ,

- the modified value is either out of the range, or
- the code entered is not a valid code

8.3.4 INDICATIONS OF THE NUS-400P AND LED STATUS

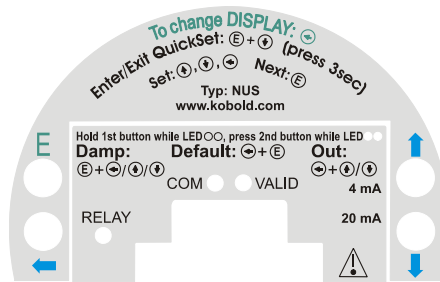
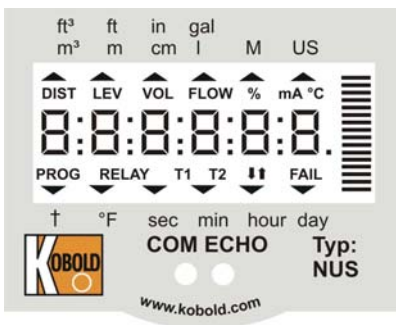

LED Indication

- **VALID (ECHO)-LED**
Lit in case of valid echo
- **RELAY-LED**
ON, when the "C2" circuit of the relay is closed

NUS-400P indications

Depending on the measurement one of the below symbols will lit and the process value displayed (see P01 chapter 9.1).

Engineering units will be indicated directly (°C, °F and mA) and by the lit arrow showing towards them on the frame

- DIST distance
- LEV level
- VOL volume
- FLOW flow
- T1/T2 totalised values
- FAIL (blinking) Error code displayed

For paging readouts NEXT \leftarrow key should be pressed.

The following process values can be displayed

- Volume / Flow – if programmed so
- Level – if programmed so
- Distance – if programmed so
- Warning indications – FAIL blinking

Display screens can be scrolled by pressing key NEXT \leftarrow .

To return to the screen of the selected measurement mode key ENTER \ominus should be pressed (see P01 chapter 6.1)

Temperature can be displayed by pressing UP \uparrow .

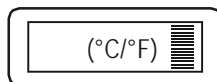

Current output value can be displayed by pressing DOWN \downarrow .

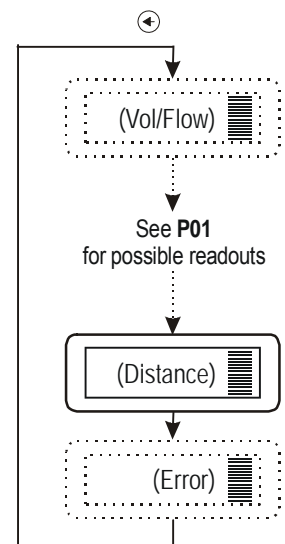
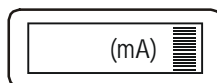

8.3.5 QUICKSET

Recommended as a simple and fast way to start up NUS-4.

QUICKSET programming (aided by 6 screens) is used in uncomplicated level metering applications to set the 6 basic parameters. The other parameters can only be modified in the Full Parameter Access Mode see 9.1 (P01).

- Engineering unit for the display (Metric or US)
- Maximum measuring distance (H)
- Assignment of min level to 4 mA
- Assignment of max level to 20 mA
- Error indication by the current output
- Damping time

QUICKSET program mode can only be used in measuring mode Level (LEV) (see P01 in 9.1 Measurement Configuration)

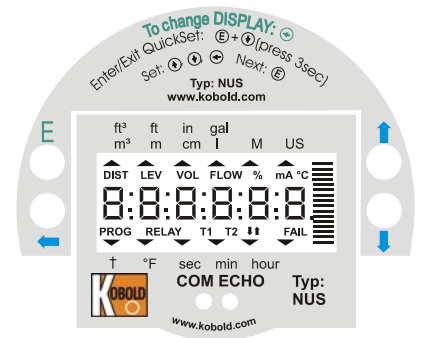

Keys	Function
ENTER (E) + DOWN (D) (press for min 3 secs!)	Enter or exit QUICKSET programming mode
UP (U), DOWN (D), NEXT (N)	Increase/decrease and move left the blinking digit
UP (U) + DOWN (D)	"GET LEVEL" - display actual level measured by the NUS-4
ENTER (E)	Save readout and step to the next screen
NEXT (N) + UP (U)	Quit Current Output Scaling without saving the modifications (CANCEL)
NEXT (N) + DOWN (D)	Display of the DEFAULT value.

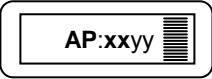
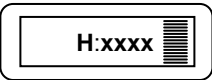
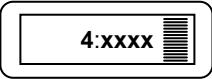
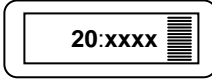
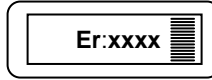
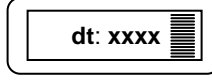
Screens	Actions
	<p>Application xx= select "EU" (European) for metric or "US" for US engineering units (Use UP ⬆ /DOWN ⬇ keys) yy= indicating "Li" for liquids DEFAULT: EU</p> <div style="border: 1px solid black; padding: 5px; text-align: center;"> <p>Programming of this parameter will result in loading the factory default with the corresponding engineering units.</p> </div>
	<p>H = xxxx maximum measuring distance – Distance between transducer face and tank bottom Manual: set value (Use UP ⬆ /DOWN ⬇ /NEXT ⬅ keys) and save it (by ENTER Ⓜ) Automatic: use the "GET LEVEL" function (UP ⬆ + DOWN ⬇) to obtain actual measured value with level in tank or a fixed target, i.e. wall. ("GET LEVEL" functions only if ECHO LED is lit) and save it as above. DEFAULT: maximum measuring distance [m], see Technical Data Table</p>
	<p>4 mA xxxx – level value assigned to 4 mA current output Manual: set level value (by UP ⬆ /DOWN ⬇ /NEXT ⬅ keys) and save it (by ENTER Ⓜ) Automatic: use the "GET LEVEL" function (UP ⬆ + DOWN ⬇) to display the actual measured value with level in tank or a fixed target, i.e. wall. ("GET LEVEL" functions only if ECHO LED is lit) and save it as above. DEFAULT: 0 m (0%, Empty tank)</p>
	<p>20 mA xxxx – level value assigned to 20 mA current output Manual: set level value (Use UP ⬆ /DOWN ⬇ /NEXT ⬅ keys) and save it (by ENTER Ⓜ) Automatic: use the "GET LEVEL" function (UP ⬆ + DOWN ⬇) to obtain actual measured value with level in tank or a fixed target, i.e. wall. ("GET LEVEL" functions only if ECHO LED is lit) and save it as above. DEFAULT: max. level = max. measuring distance – dead band [m] (100%, Full tank) (See Technical Data Table)</p>
	<p>Error indication by the current output – select "Hold", 3.8 mA or 22 mA (by UP ⬆ / DOWN ⬇ key) and save it as above. DEFAULT: hold last value</p>
	<p>damping time: select required damping time (by UP ⬆ /DOWN ⬇ key) and save it as above. DEFAULT: 60 sec for liquids, 300 sec for solids</p>



Note: – Current output can also be programmed for inverted operation: 4 mA= 100 % (Full), 20 mA= 0 % (Empty)
 – Description of failures can be found under the chapter 10 Error codes.

8.3.6 Full Parameter Access



Full Parameter Access is the highest programming level to access all features:

Example:

- Setting the measurement
- Programming of the output
- Optimization of measurement
- Selection of 11 pre-programmed tank shapes for volume measurement
- Selection of 20 pre-programmed measurement channels for the flow measurement in open channels

Keys	Function
ENTER (E) + NEXT (N) (press for 3 seconds)	Enter or exit Full Parameter Access programming mode.

In this programming mode, the display will indicate:

yy:xxxx 	yy Parameter Address (P01, P02 ... P99)
	xxxx Parameter value (dcba)
	 Bar graph



Note: Measuring is going on during programming in accordance with the old parameter set. New parameter set will be valid after returning to the Measurement to the Programming Mode.

Steps and indications of the Full Parameter Access programming mode

pressing Keys	while Parameter Address is blinking	while Parameter Value is blinking
ENTER (E)	Go to the Parameter Value	Save the modification of the Parameter Value and return to the Parameter Address
NEXT (N) + UP (U)	Cancel all modifications of the actual programming phase. Pressing for 3 sec is required while CANCEL will be displayed for warning	Neglect the modification of the Parameter Value. and return to the Parameter Address without saving the modifications
NEXT (N) + DOWN (D)	Reset entire device to Factory Default. Since this action will reset all parameters, "LOAD" will appear on the display: - to confirm, press - to escape, press any other key - Exception: clearing TOT 1 (See at P77)	Display default of the Parameter Values (it can be saved by pressing ENTER (E))
NEXT (N)	Move blinking (changeability) of the digit to the left	
UP (U) / DOWN (D)	Modify the blinking digit (increase, decrease) or scroll up/down	

9. Parameters – Description and Programming

9.1 Measurement Configuration

P00:- cba Application/Engineering Units

Programming of this parameter will result in loading the factory default with the corresponding engineering units.

a	Operating (measurement) mode
0	Liquid level measurement

b	Engineering units (according to "c")	
	Metric	US
0	m	ft
1	cm	inch

Attention: mind the sequence!
When programming this parameter the right value "a" will be blinking first.

c	Calculation system
0	Metric
1	US

FACTORY DEFAULT: 000

P01:- ba Measurement Mode – Bargraph

Parameter value „a" will determine the basic measurement value that will be displayed and proportional with the current output. Depending on the value of "a" process values as listed in the 3d column can also be displayed by pressing NEXT (⬅). For return to the display of the basic value the ENTER (⏏) key should be pressed.

a	Measurement Mode	Display symbol	Displayed values
0	Distance	DIST	Distance
1	Level	LEV	Level, Distance
2	Level in percentage	LEV%	Level%, Level, Distance
3	Volume	VOL	Volume, Level, Distance
4	Volume in percentage	VOL%	Volume%, Volume, Level, Distance
5	Flow	FLOW	Flow, TOT1, TOT2, Level, Distance

Attention: mind the sequence!
When programming this parameter the right value "a" will be blinking first.

Parameter value "b" will determine that the height of the Bargraph will be proportional to the current output or to the Echo strength.

b	Bargraph indication
0	Echo strength
1	Current output

FACTORY DEFAULT: 11

P02:- cba Calculation units

a	Temperature
0	°C
1	°F

Attention: mind the sequence!
When programming this parameter the right value "a" will be blinking first.

This table is interpreted according to P00(c), P01(a) and P02(c) and is irrelevant in case of percentage measurement (P01(a)= 2 or 4)

b	Volume		Weight (set also P32)		Volume flow	
	Metric	US	Metric	US	Metric	US
0	m ³	ft ³	-	lb (pound)	m ³ /time	ft ³ /time
1	liter	gallons	tons	tons	liter/time	gallons/time

c	Time
0	Sec
1	Min
2	Hour
3	Day

FACTORY DEFAULT: 000

P03:- - - a Values displayed - Rounding

It is important to keep in mind that the instrument is measuring distance as basic quantity.

Measured Distance	Resolution
X _{min} – 2m	1mm
2m – 5m	2mm
5m – 10m	5mm
10m over	10mm

The resolution depending on the distance can be considered as a kind of rounding that will be contained in all further value (of level, volume or volume flow) calculated. Therefore if programmed for DIST or LEV measurement the setting of P03 is irrelevant.

Displayed VOL or FLOW

Displaeyed Value	Display Format
0,000 – 9,999	x,xxx
10,000 – 99,999	xx,xx
100,000 – 999,999	xxx,x
1000,000 – 9999,999	xxxx,x
10000,000 – 99999,999	xxxxx,x
100000,000 – 999999,999	xxxxxx,x
1 millió – 9,99999*10 ⁹	x,xxxx : e (exponential format)
1*10 ¹⁰ over	(overflow) Err4

Obviously the decimal position will be shifted with increasing value displayed. (See table at the left). Values over one million will be displayed in exponential format whereas the value (e) represents the exponent. Over the value of 1x10¹⁰ Err4 (overflow) will be displayed.

Rounding

Parameter Value "a"	Steps In The Displayed Value
0	1 (no rounding)
1	2
2	5
3	10
4	20
5	50

A couple of millimetres of fluctuation of the basic DIST value (e.g. due to waves) will be enlarged by the mathematical operations. This enlarged fluctuation in displaying VOL or FLOW can (if disturbing) be avoided by rounding to be set in P03. Rounding value 2, 5, 10 etc represents the steps by which the calculated value will be changed in its (one or two) last digit(s).

Examples:

P03=1 steps by 2: 1,000; 1,002; 1,004

P03=5 steps by 50: 1,000; 1,050; 1,100 or 10,00; 10,05(0); 10,10(0); 10,15(0)

(the 0 from the steps 50, 100, 150 etc will not be displayed)

FACTORY DEFAULT: 0

P04 Maximum Distance to be Measured (H)

The maximum distance to be measured is the greatest distance between the surface of the transducer and the level to be measured.

This is the only parameter that has to be programmed for each application other than distance (however to avoid disturbing effect of possible multiple echos it is suggested to do this in distance measurement applications too).

Values of the maximum measuring distance will be displayed as below.

Engineering Unit	Display Format
m	X,XXX OR XX,XX
cm	XXX,X
ft	XX,XX OR XXX,X
inch	XXX,X

The factory programmed, greatest distances (DEFAULT values) which **can be measured** by the units are listed in the table below. For the actual application the maximum distance **to be measured** i.e. the distance between the sensor and the bottom of the tank should be entered in P04.

To obtain the best accuracy, measure this distance in the empty tank with the NUS-4 by using the "GET LEVEL" function (by double key pressing of UP ⬆ + DOWN ⬇) provided the bottom is flat. Enter the actual measured value displayed as P04.

Model	Factory default of maximum measuring distance (m/ft)
NUS-4x04	4/13
NUS-4x06	6/20
NUS-4x08	8/26
NUS-4x10	10/33
NUS-4x15	15/49
NUS-4x25	25/82

FACTORY DEFAULT: acc. to the table

P05: Minimum measuring distance (Dead zone- Close-end blocking)

The NUS-4 will not accept any echo within the blocking distance set here.

Automatic Close-end-blocking (Automatic Dead Band control)

By using the factory default value, the unit will automatically set the smallest possible close-end-blocking distance i.e. the dead band.

Manual close-end-blocking

Manual close-end-blocking should be used for example to block out the echo originating from the bottom rim of a stand-off pipe or from any object protruding into the ultrasonic cone near to the transmitter.

By entering a value, higher than the factory default, the minimum measuring range will be extended and fixed to the specified value.

To return to the factory programmed (DEFAULT value) of the minimum measuring distance press NEXT ⬅ + DOWN ⬇ .

Model	Factory default of minimum measuring distance X_m (m/ft)
NUS-4x04	0,2 / 0,65
NUS-4x06	0,25 / 0,82
NUS-4x08	0,35 / 1,2
NUS-4x10	0,35 / 1,2
NUS-4x15	0,45 / 1,5
NUS-4x25	0,60/2,02

FACTORY DEFAULT: automatic dead band control

P06: Far end blocking

Far end blocking is used to neglect incorrect level/volume readings and output actions below a pre-set level programmed in P06.

A). Level measurement

The far-end blocking can be used to avoid disturbing effect of stirrer or heaters at the bottom of the tanks.

If the level of the medium sinks below the blocked out range:

- "Sub 0" will be indicated for the level and volume
- Distance value is not interpretable
- Current output will hold the value corresponding to the far end blocking level

If the medium level is above the blocked out range:

The calculation of level and volume will be based on the programmed tank dimensions, therefore the measured or calculated process values will not be influenced in any way, by the far end blocking value.

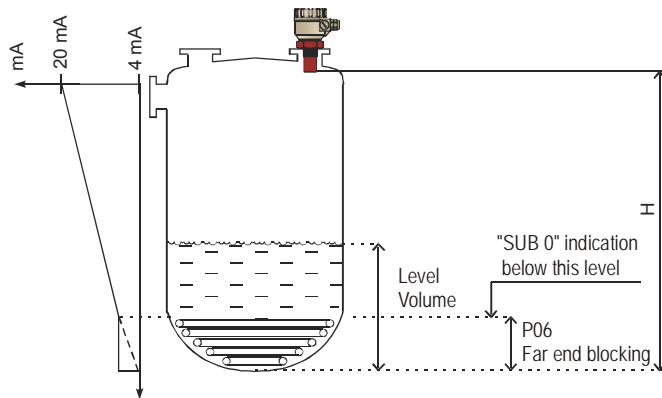

B). Open channel flow metering

Far end blocking will be used for those small levels below which the accurate volume flow calculation is no longer possible.

If the liquid level in the flume/weir falls below the blocked out range:

The NUS-4 will act as follows:

- Indicate "No Flow" on the Display
- Hold last valid data on the current output.

If the level in the flume/weir is above the blocked out range:

The calculation of volume flow will be based on the programmed flume/weir data; therefore the measurement values will not be influenced in any way, by the far end blocking value.

FACTORY DEFAULT: 0

9.2 Current Output

P10: Value (of distance, level, volume or flow) assigned to 4 mA current output

P11: Value (of distance, level, volume or flow) assigned to 20 mA current output

Values are interpreted according to **P01(a)**. Please note that in case of programming for (LEV or VOL) % measurement the min and max value has to be entered in the relevant engineering units of LEV (m, ft) or VOL (m³, ft³).

Assignment can be made so that the proportion between the change of the (measured or calculated) process value and the change of the current output be either direct or inverse. E.g. lev 1 m assigned to 4mA and lev 10 m assigned to 20 mA represents direct proportion and lev 1 m assigned to 20 mA and lev 10 m assigned to 4 mA represents the inverse proportion.

FACTORY DEFAULT:

P10 0 level (max distance)

P11 max level (min distance) H

P12: - - - a Error indication by the current output

In case of error the NUS-4 will provide one of the current outputs below. (For errors and their interpretation see Chapter 10).

a	ERROR INDICATION (ACCORDING TO NAMUR)
0	Hold last value
1	3.8 mA
2	22 mA

FACTORY DEFAULT: 0

9.3 Relay Output

P13: - - - a Relay function

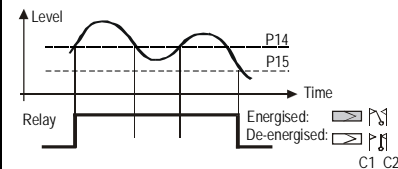
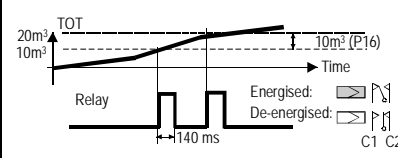
a	Relay function	Also set
0	<p>DIFFERENTIAL LEVEL CONTROL (Hysteresis control)</p> <p>Relay is energised if the measured or calculated value exceeds the value set in P14. Relay is de-energised if the measured or calculated value descends under the value set in P15.</p>	 <p>P14, P15</p> <p>There is a need to set (in level min 20mm) hysteresis between P14 and P15</p> <p>P14 > P15 – normal operation</p> <p>P14 < P15 – inverted operation</p>
1	Relay is energised in case of Echo Loss	-
2	Relay is de-energised in case of Echo Loss	-
3	<p>COUNTER</p> <p>Used for open channel flow metering.</p> <p>A 140 msec pulse is generated every 1, 10, 100, 1.000 or 10.000 m³ according to P16.</p>	 <p>P16= 0: 1m³</p> <p>P16= 1: 10 m³</p> <p>P16= 2: 100 m³</p> <p>P16= 3: 1.000 m³</p> <p>P16= 4: 10.000 m³</p>

In de-energised state of the device the „C1” circuit is closed.

The „Relay” LED is on when the „C2” circuit is closed.

FACTORY DEFAULT: **P13=2**

P14: - - - - Relay parameter – Operating value

P15: - - - - Relay parameter – Releasing value

P16: - - - - Relay parameter – Pulse rate P13(3)

FACTORY DEFAULT: **P14=0, P15=0, P16=0**

9.4 Measurement Optimisation

P20: - - - a Damping

This parameter can be used to reduce unwanted fluctuation of the display and output.

a	Damping time (seconds)	LIQUIDS	
		None/moderate fume or waves	Heavy/dense fume or turbulent waves
0		no filter	
1	3	applicable	not recommended
2	6	recommended	applicable
3	10	recommended	recommended
4	30	recommended	recommended
5	60	recommended	recommended

FACTORY DEFAULT: 60 sec

P22: - - - a Dome top tank compensation

This parameter can be used to reduce disturbing effect of possible multiple echos.

a	Compensation	Applied
0	OFF	In case the NUS-4 is not mounted in the centre of the top and the top is flat.
1	ON	In case the NUS-4 is mounted in the centre of a tank with dome-shaped top

FACTORY DEFAULT: 0

P24: - - - a Target tracking speed

In this parameter evaluation can be speed up at the expense of the accuracy.

a	Tracking speed	Remark
0	Standard	For most applications
1	Fast	For fast changing level
2	Special	Only for special applications (measuring range is reduced to 50% of the nominal value) The measuring window is inactive and the NUS-4 will respond practically instantly to any target. Recommended to fast target tracking, but usually not applicable for level metering.

FACTORY DEFAULT: 0

P25: - - - a Selection of Echo within the measuring window

A so-called measuring window is formed around the echo signal. The position of this measuring window determines the flight time for calculation of the distance to the target. (the picture below can be seen on the test oscilloscope)

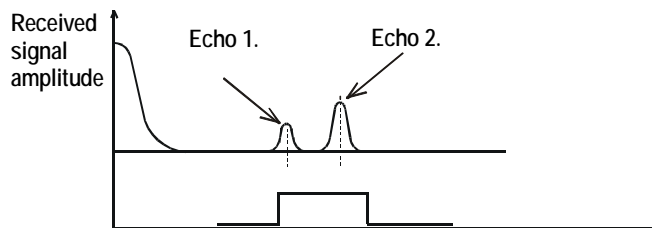

Some applications involve multiple (target + disturbing) echoes even within the measuring window. Basic echo selection will be done by the Quest + software automatically. This parameter only influences the echo selection within the measuring window.

a	Echo in the window to be selected	Remark
0	With the highest amplitude	For most applications (both with liquids and solids)
1	First one	For liquids applications with multiple echoes within the Measuring Window

FACTORY DEFAULT: 0

P26: Level elevation rate (filling speed) (m/h)

P27: Level descent rate (emptying speed) (m/h)

These parameters provide additional protection against echo loss in applications involving very heavy fuming.

The parameters must not be smaller than the fastest possible filling/emptying rate of the actual technology.

For all other applications, use the factory default setting.

FACTORY DEFAULT:

2000 for both **P26** and **P27**

P28: - - - a Echo loss indication

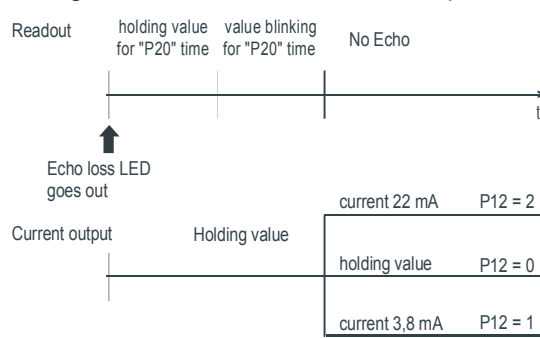
a	Echo loss indication	Remark
0	Delayed indication	<p>During echo-loss, display and analogue output will hold last value. If the echo-loss prevails for 10 sec plus the time period set in P20 (damping time), the reading on the display will change to "no Echo" and the outputs will change according to the "Error Indication Mode" pre-set in P12</p> 
1	No indication	For the time of echo-loss, display and analogue output will hold last value.
2	Advance to full	During echo-loss in case of filling, the reading on the display and analogue output will shift towards the "full" tank state with a level elevation rate (filling speed) pre-set in P26
3	Immediate indication	In case of echo-loss, the display will immediately change to "no Echo", and the outputs will change according to the "Error Indication Mode" pre-set in P12
4	Empty tank indication	Echo-loss may occur in completely empty tanks with a spherical bottom due to deflection of the ultrasonic beam, or in case of silos with an open outlet. If the echo is lost when the tank is completely empty, the indication will correspond to empty tank, in all other cases echo-loss indication will function according to the "Delayed".

FACTORY VALUE: 0

P29: Blocking out of disturbing object

One fixed object in the tank, disturbing the measurement, can be blocked out. Enter distance of the object from the transducer. Use the Echo Map (**P70**) to read out the precise distance of disturbing objects.

FACTORY DEFAULT: 0

P31: Sound velocity at 20°C (m/sec or ft/sec depending on P00(c))

Use this parameter if the sound velocity in the gases above the measured surface differs largely from that of in air.

Recommended for applications where the gas is more or less homogeneous. If it is not, the accuracy of the measurement can be improved using 32-point linearisation (P48, P49).

For sound velocities in various gases see section "Sound Velocities".

FACTORY DEFAULT: Metric (P00: "EU"): 343.8 m/s, US (P00: "US"): 1128 ft/s

P32: Specific gravity

If you enter a value (other than "0") of specific gravity in this parameter, the weight will be displayed instead of VOL.

FACTORY DEFAULT: 0 [kg/dm³] or [lb/ft³] depending on P00 (c)

9.5 Volume Measurement

P40:- - ba Tank shape

ba	Tank shape	Also to be set	<p style="text-align: center;">Attention! The value „a” determining the shape of the tank should be set first.</p>
b0	Standing cylindrical tank shape (value of "b" as below)	P40 (b), P41	
01	Standing cylindrical tank with conical bottom	P41, P43, P44	
02	Standing rectangular tank (with chute)	P41, P42, (P43, P44, P45)	
b3	Lying cylindrical tank shape (value of "b" as below)	P40 (b), P41, P42	
04	Spherical tank	P41	

FACTORY DEFAULT: 00

P41-45: Tank dimensions

Standing cylindrical tank with hemispherical bottom

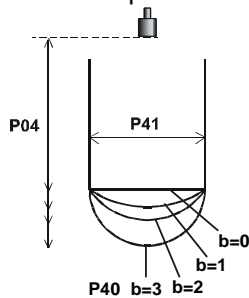

Standing cylindrical tank with conical bottom

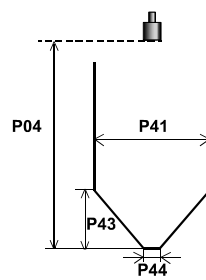

Standing rectangular tank with or without chute

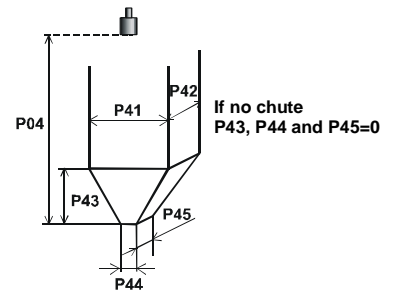

Lying cylindrical tank

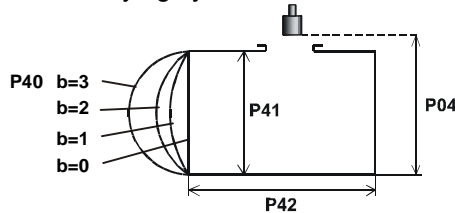

Spherical tank

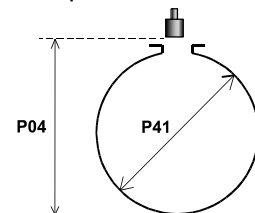

9.6 Volume Flow Measuring

P40: - - ba Devices, formula, data

ba	Devices, formula, data	Also to be set
00	Under preparation	
01	Under preparation	
02	Under preparation	
03	Under preparation	
04	Under preparation	
05	Under preparation	
06	Under preparation	
07	Under preparation	
08	Under preparation	
09	General PARSHALL flume	P46, P42
10	PALMER-BOWLUS (D/2)	P46, P41
11	PALMER-BOWLUS (D/3)	P46, P41
12	PALMER-BOWLUS (Rectangular)	P46, P41, P42
13	Khafagi Venturi	P46, P42
14	Bottom-step weir	P46, P42
15	Suppressed rectangular or BAZIN weir	P46, P41, P42
16	Trapezoidal weir	P46, P41, P42
17	Special trapezoidal (4:1) weir	P46, P42
18	V-notch weir	P46, P42
19	THOMSON (90°-notch) weir	P46
20	Circular weir	P46, P41
21	General flow formula: $Q[l/s] = 1000 \cdot P41 \cdot h^{P42}$, h [m]	P46, P41, P42
	General PARSHALL flume	

FACTORY DEFAULT: 0

NUS-4

P41-45: Flume/weir dimensions

FACTORY DEFAULT: 0

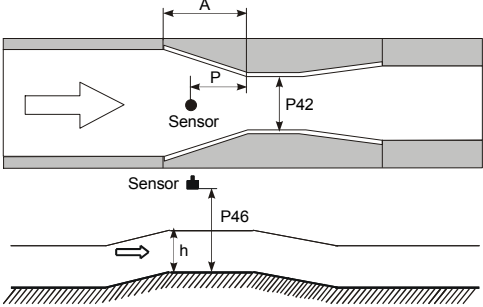
<p>P40= 00</p>	<p>KOBOLD Parshall Channels (in preparation)</p>															
<p>P40= 09</p>	<p>General Parshall flume $0.305 < P42(\text{width}) < 2.44$ $Q[\text{m}^3/\text{s}] = 372 \cdot P42 \cdot (h/0.305)^{1.569} P42^{0.026}$ $2.5 < P42$ $Q[\text{m}^3/\text{s}] = K \cdot P42 \cdot h^{1.6}$ $P = 2/3 \cdot A$</p> <table border="1" data-bbox="486 577 740 745"> <thead> <tr> <th>P42[m]</th> <th>K</th> </tr> </thead> <tbody> <tr> <td>3.05</td> <td>2.450</td> </tr> <tr> <td>4.57</td> <td>2.400</td> </tr> <tr> <td>6.10</td> <td>2.370</td> </tr> <tr> <td>7.62</td> <td>2.350</td> </tr> <tr> <td>9.14</td> <td>2.340</td> </tr> <tr> <td>15.24</td> <td>2.320</td> </tr> </tbody> </table>	P42[m]	K	3.05	2.450	4.57	2.400	6.10	2.370	7.62	2.350	9.14	2.340	15.24	2.320	
P42[m]	K															
3.05	2.450															
4.57	2.400															
6.10	2.370															
7.62	2.350															
9.14	2.340															
15.24	2.320															

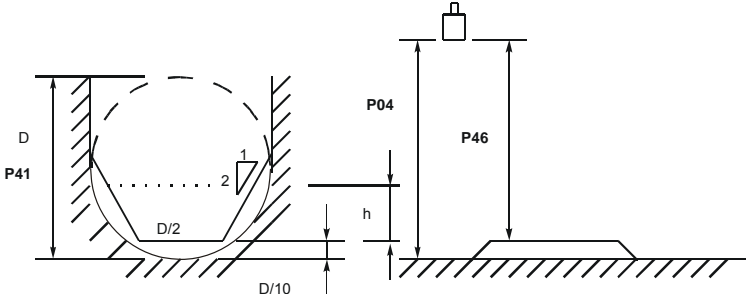
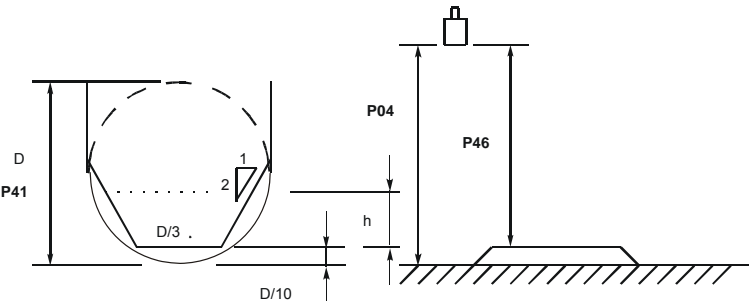
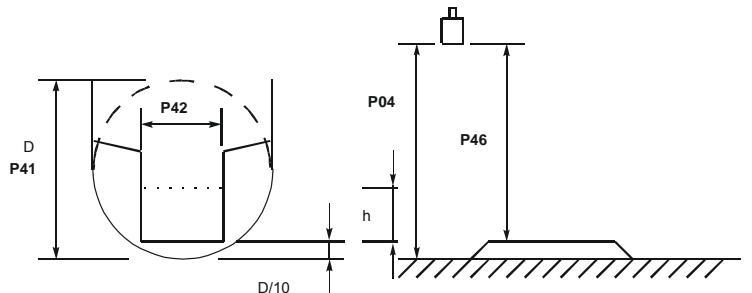
<p>P40= 10</p>	<p>Palmer-Bowlus (D/2) flume $Q[\text{m}^3/\text{s}] = f(h1/P41) \cdot P41^{2.5}$, where $h1[\text{m}] = h + (P41/10)$</p>	
<p>P40= 11</p>	<p>Palmer-Bowlus (D/3) flume $Q[\text{m}^3/\text{s}] = f(h1/P41) \cdot P41^{2.5}$, where $h1[\text{m}] = h + (P41/10)$</p>	
<p>P40= 12</p>	<p>Palmer-Bowlus (Rectangular) flume $Q[\text{m}^3/\text{s}] = C \cdot P42 \cdot h^{1.5}$, where $C = f(P41/P42)$</p>	

<p>P40= 13</p>	<p>Khafagi Venturi flume</p> <p>$Q[\text{m}^3/\text{s}] = \mathbf{P42} * 1.744 * h^{1.5} + 0.091 * h^{2.5}$</p>	
<p>P40= 14</p>	<p>Bottom step weir</p> <p>$0.0005 < Q[\text{m}^3/\text{s}] < 1$</p> <p>$0.3 < \mathbf{P42}[\text{m}] < 15$</p> <p>$0.1 < h[\text{m}] < 10$</p> <p>$Q[\text{m}^3/\text{s}] = 5.073 * \mathbf{P42} * h^{1.5}$</p> <p>Accuracy: $\pm 10\%$</p>	<p style="text-align: center;">P40-14</p>
<p>P40= 15</p>	<p>Suppressed rectangular or BAZIN weir</p> <p>$0.001 < Q[\text{m}^3/\text{s}] < 5$</p> <p>$0.15 < \mathbf{P41}[\text{m}] < 0.8$</p> <p>$0.15 < \mathbf{P42}[\text{m}] < 3$</p> <p>$0.015 < h[\text{m}] < 0.8$</p> <p>$Q[\text{m}^3/\text{s}] = 1.7599 * [1 + (0.1534 / \mathbf{P41})] * \mathbf{P42} * (h + 0.001)^{1.5}$</p> <p>Accuracy: $\pm 1\%$</p>	<p style="text-align: center;">P40-15</p>
<p>P40= 16</p>	<p>Trapezoidal weir</p> <p>$0.0032 < Q[\text{m}^3/\text{s}] < 82$</p> <p>$20 < \mathbf{P41}[\text{m}] < 100$</p> <p>$0.5 < \mathbf{P42}[\text{m}] < 15$</p> <p>$0.1 < h[\text{m}] < 2$</p> <p>$Q[\text{m}^3/\text{s}] = 1.772 * \mathbf{P42} * h^{1.5} + 1.320 * \text{tg}(\mathbf{P41}/2) * h^{2.47}$</p> <p>Accuracy: $\pm 5\%$</p>	<p style="text-align: center;">P40-16</p>
<p>P40= 17</p>	<p>Special Trapezoidal (4:1) weir</p> <p>$0.0018 < Q[\text{m}^3/\text{s}] < 50$</p> <p>$0.3 < \mathbf{P42}[\text{m}] < 10$</p> <p>$0.1 < h[\text{m}] < 2$</p> <p>$Q[\text{m}^3/\text{s}] = 1.866 * \mathbf{P42} * h^{1.5}$</p> <p>Accuracy: $\pm 3\%$</p>	<p style="text-align: center;">P40-17</p>
<p>P40= 18</p>	<p>V-notch weir</p> <p>$0.0002 < Q[\text{m}^3/\text{s}] < 1$</p> <p>$20 < \mathbf{P42}[\text{m}] < 100$</p> <p>$0.05 < h[\text{m}] < 1$</p> <p>$Q[\text{m}^3/\text{s}] = 1.320 * \text{tg}(\mathbf{P42}/2) * h^{2.47}$</p> <p>Accuracy: $\pm 3\%$</p>	<p style="text-align: center;">P40-18</p>

NUS-4

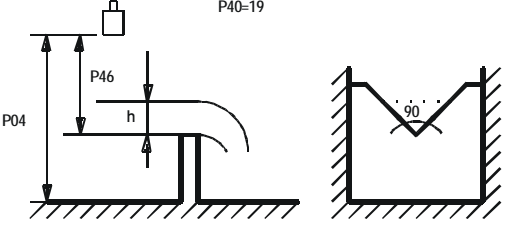
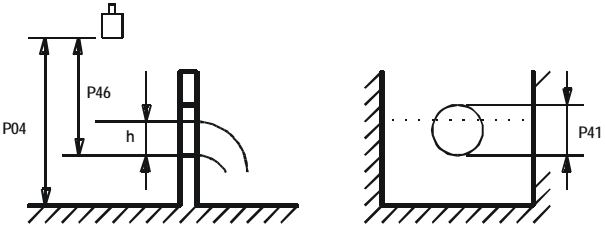
<p>P40= 19</p>	<p>THOMSON (90°-notch) weir $0.0002 < Q[m^3/s] < 1$ $0.05 < h[m] < 1$ $Q[m^3/s] = 1.320 \cdot h^{2.47}$ Accuracy: $\pm 3\%$</p>	
<p>P40= 20</p>	<p>Circular weir $0.0003 < Q[m^3/s] < 25$ $0.02 < h[m] < 2$ $Q[m^3/s] = m \cdot b \cdot D^{2.5}$ $m = 0.555 + 0.418h/P41 + (P41/(0.11 \cdot h))$ Accuracy: $\pm 5\%$</p>	

P46: Distance between transducer face and level of Q=0

P46 is *always* the distance between the transducer face and the level, where the volume flow is 0.

FACTORY DEFAULT: 0

9.7 32- Point Linearisation

P47: - - - a Linearisation

Linearisation is the method of assigning requested (calibrated or calculated) level, volume or flow to values measured by the transmitter.

It can be used for instance if the sound velocity is not known (LEVEL⇒LEVEL) or in the case of tank with other shape than under 6.4 or open channel other than under 6.5 (LEVEL ⇒ VOLUME or LEVEL ⇒ FLOW).

a	Linearisation
0	OFF (FACTORY DEFAULT)
1	ON

P48: Linearisation table

Data-pairs of the linearisation table are handled in a 2x32 matrix, consisting of two columns.

Left column "L"	Right column "r"
LEVEL measured	LEVEL or VOLUME or FLOW to be transmitted and displayed

The left column values (indicated on the display as "L") contain the measured LEVEL values. The right column values (indicated on the display as "r") contain the calibrated values and are interpreted according to the selected measurement value in **P01(a)**.

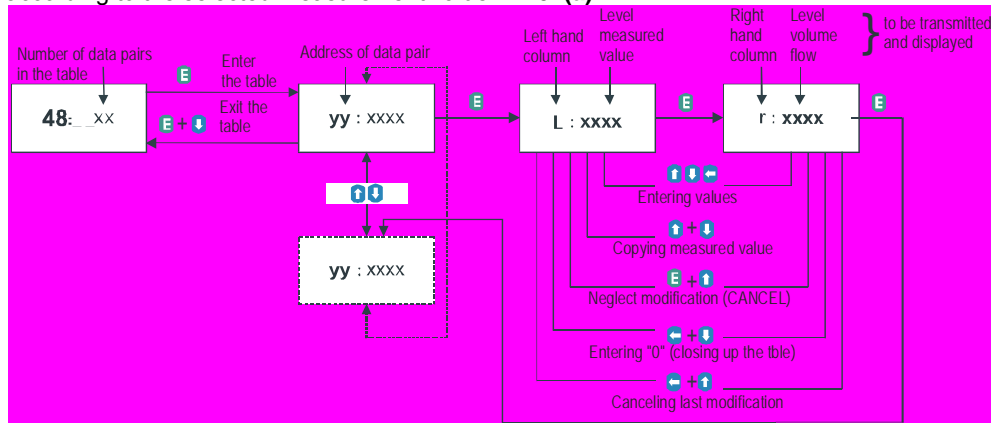

Conditions of correct programming of the data pairs

Left column "L"	Right column "r"
L(1)= 0	r(1)
L(i)	r(i)
:	:
L(j)	r(j)

The table must always start with: L(1)= 0 and r(1)= value (assigned to 0 level)

The table must be ended either with the 32nd data pair i.e. j=32 or if the linearisation table contains less than 32 data-pairs j<32, the table must be closed by a level value "0" e.g. L(j<32)= 0.

The NUS-4 will ignore data after recognising level value "0" with serial number other than "1".

If the above conditions are not met, error codes will be displayed (see chapter: Error Codes).

9.8 Informational Parameters (Read Out Parameters)

P60: Overall operating hours of the unit (h)

Indication varies according to the elapsed time:

Operating hours	Indication form
0 to 999.9h	xxx,x
1000 to 9999h	xxxx
Over 9999h	X,xx: e meaning x,xx 10 ^e

P61: Time elapsed after last switch-on (h)

P62: Operating hours of the relay (h)

P63: Number of switching cycles of the relay (h)

Indications are the same as in P60.

P64: Actual temperature of the transducer (°C/°F)

P65: Maximum temperature of the transducer (°C/°F)

P66: Minimum temperature of the transducer (°C/°F)

In case of a breaking in the temperature circuit „tErr” will be displayed. The transmitter will perform temperature correction corresponding to 20°C.

P70: Number of Echoes / Echo Map

NUS-4 is monitoring the echo conditions.

Entering this parameter will save the actual echo map.

Number, distance and amplitude of these echoes can be read-out one by one.

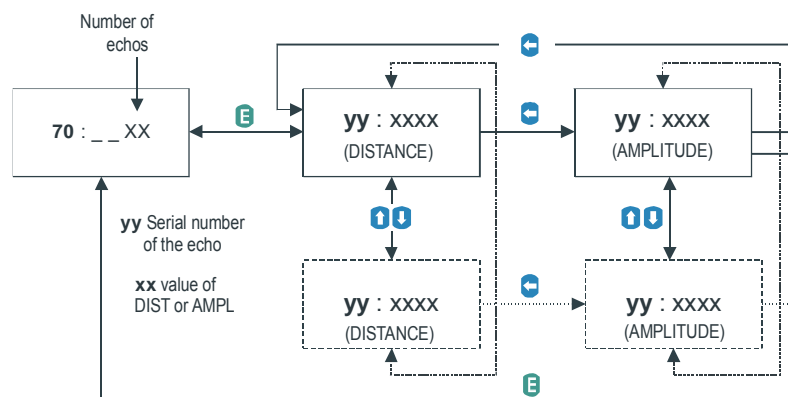

P71: Distance of the of Measuring Window

P72: Amplitude of the Echo in the Measuring

P73: Echo Position (time) :(ms)

P74: Signal To Noise Ratio

Ratio	Measurement conditions
Over 70	Excellent
Between 70 and 30	Good
Under 30	Unreliable

P75: Blocking Distance

The actual close-end blocking distance will be displayed (provided automatic blocking was selected in P05).

9.9 Additional Parameters of Flow Metering in Open Channels

P76: Head of flow (LEV)

The Headwater value can be checked here. This is the “h” value in the formula for flow calculation.

P77: TOT1 volume flow totaliser (resetable)

P78: TOT2 volume flow totaliser (non-resetable)

Resetting TOT1 totaliser:

- 1.) Go to the parameter **P77**.
- 2.) Press NEXT (⬅) + DOWN (⬇) simultaneously.
- 3.) Display will indicate: “t1 Clr”.
- 4.) Press ENTER (⏎) to delete.

9.10 Test Parameters

P80: Current output test (mA)

Going to this parameter, the actual current output (corresponding to the measured process value) will be displayed. By pressing ENTER (⏎) the (now blinking) current value can be set for any value between 3,9 and 20.5 mA. The current output has to show the same value which can be checked by an ampere meter, according to the description under 4.4. Press ENTER (⏎) to quit test mode and return the parameter address

P81: - - - a Relay test

The actual state of the relay can be seen on the display (code according to the table below and symbol on the screen). Test the relay by pressing UP (⬆) and DOWN (⬇) while observing change of the symbol and the code or listening to the ticking of the relay or checking on-off resistance by a suitable resistance meter.

a	Relay state
0	De-energised
1	Energised

P97: b:a.aa Software code

- a.aa: Number of the software version
- b: Code of the special version

9.11 Simulation

This function enables the user to test the settings of the outputs. The NUS-4 can simulate the static or continuous change of level according to the simulation cycle time, high level and low level set in P85, P86 and P87. (The simulation levels must be within the programmed measuring range set in P04 and P05.) After selecting simulation type in P85 and setting simulation values Measurement Mode has to be re-entered. While the NUS-4 is in simulation mode the DIST, LEV or VOL symbol will be blinking. To quit Simulation Mode P84= 0 should be set.

P84: - - - x Selection of the simulation

X	Simulation type
0	No simulation
1	The level changes continuously up and down between the level values set in P86 and P87 with a cycle time set in P85

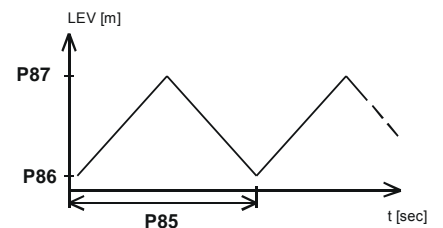

P85:	Cycle time for simulation (sec)
P86:	Simulated low level value (m)
P87:	Simulated high level value (m)

9.12 Access Lock

P99: dcba Access Lock by Secret Code

The purpose of this feature is to provide protection against accidental (or intentional) re-programming of parameters.

The Secret Code can be any value other than **0000**. Setting a Secret Code will automatically be activated when the NUS-4 is returned to the Measurement Mode. If the Secret Code is activated, the parameters can only be viewed, this is indicated by the a flashing colon ":" between the parameter address and the parameter value.

In order to program the device locked by a secret code, first enter the Secret Code in **P99**. The Secret Code is re-activated each time the NUS-4 is returned to Measurement Mode.

To delete the Secret Code, enter the Secret Code in **P99**. After confirming it with **[E]** re-enter the parameter **P99** and enter **0000**.

[dcba (Secret Code)] → [E] → [E] → [0000] → [E] ⇒ Secret Code deleted

10. Error Codes

Error Code	Error description	Causes and solutions
1	Memory error	Contact local agent
No Echo	Echo loss	No echo received (no reflection) See Action 5 and 6
3	Hardware error	Contact local agent
4	Display overflow	Check settings
5	Sensor error or improper installation/mounting, level in the dead band	Verify sensor for correct operation and check for correct mounting according to the User's Manual
6	The measurement is at the reliability threshold	Better location should be tried.
7	No signal received within the measuring range specified in P04 and P05	Review programming, also look for installation mistake
12	Linearisation table error: both L(1) and L(2) are zero (no valid data-pairs)	See the Section "Linearisation"
13	Linearisation table error: there are two same L(i) data in the table	See the Section "Linearisation"
14	Linearisation table error: the r(i) values are not monotone increasing	See the Section "Linearisation"
15	Linearisation table error: measured Level is higher than the last Volume or Flow data-pair	See the Section "Linearisation"
16	The check sum of the program in the EEPROM is wrong	Contact local agent
17	Parameter consistency failure	Check programming
18	Hardware failure	Contact local agent

11. Parameter Table

Par.	Page	Description	Value				Par.	Page	Description	Value				
			d	c	b	a				d	c	b	a	
P00	18	Application/Engineering Units					P28	25	Echo loss indication					
P01	18	Measurement Mode					P29	25	Blocking out of disturbing object					
P02	19	Calculation units					P30		N.A.					
P03	19	Rounding					P31	26	Sound velocity in different gases					
P04	20	Maximum Measuring Distance					P32	26	Specific gravity					
P05	20	Minimum Measuring Distance					P33		N.A.					
P06	21	Far End Blocking					P34	38	Logging mode					
P07		N.A.					P35	39	Log value 1 and log value 2					
P08		N.A.					P36	39	Log value 1 and log value 2					
P09		N.A.					P37	40	Real-time clock, year					
P10	21	Value assigned to „4 mA”					P38	40	Real-time clock, month and day					
P11	21	Value assigned to „20 mA”					P39	40	Real-time clock hour and minute					
P12	22	“Error” indication by the current output					P40	27	Selection of tank shape/ open channel					
P13	22	Relay function					P41	26	Dimensions of tank / Open Channel					
P14	Fehler! Text mark e nicht defini ert.	Relay parameter – Operating value					P42	26	Dimensions of tank / Open Channel					
P15		22	Relay parameter – Releasing value					P43	26	Dimensions of tank / Open Channel				
P16		22	Relay parameter – Pulse rate					P44	26	Dimensions of tank / Open Channel				
P17			N.A.					P45	26	Dimensions of tank / Open Channel				
P18			N.A.					P46	30	Dist. Btw. Transducer face and level of Q=0				
P19			N.A.					P47	31	Linearisation				
P20		23	Damping					P48	31	Linearisation table				
P21			N.A.					P49		N.A.				
P22		23	Dome top tank compensation					P50		N.A.				
P23			N.A.					P51		N.A.				
P24	23	Target tracking speed					P52		N.A.					
P25	24	Selection of Echo in the measuring window					P53		N.A.					
P26	24	Level elevation rate					P54		N.A.					
P27	24	Level descent rate					P55		N.A.					
P56		N.A.					P78	33	TOT2 volume flow totaliser					
P57		N.A.					P79		N.A.					
P58		N.A.					P80	33	Current generator test					
P59		N.A.					P81	33	Relay test					
P60	32	Overall operating hours of the unit					P82		N.A.					
P61	32	Time elapsed after last switch-on					P83		N.A.					
P62	32	Operating hours of the relay					P84	33	Simulation mode					
P63	32	Number of switching cycles of the relay					P85	34	Simulation cycle time					
P64	32	Actual temperature of the transducer					P86	34	Simulation low level					
P65	28	Maximum temperature of the transducer					P87	34	Simulation high level					
P66	32	Minimum temperature of the transducer					P88		N.A.					
P67		N.A.					P89		N.A.					
P68		N.A.					P90		N.A.					
P69		N.A.					P91		N.A.					
P70	32	Echo Map					P92		N.A.					
P71	32	Distance of the measuring window					P93		N.A.					
P72	32	Amplitude of the in the measuring					P94		N.A.					

Par.	Page	Description	Value	Par.	Page	Description	Value
		window					
P73	32	Distance of the in the measuring window		P95		N.A.	
P74	32	Signal / noise ratio		P96		N.A.	
P75	32	Blocking Distance		P97	33	Software code	
P76	33	Waterhead of the flow		P98		N.A.	
P77	33	TOT1 volume flow totaliser		P99	34	Access lock	

12. Sound Velocities in Different Gases

The following table contains the sound velocity of various gases measured at.

Gases		Sound Velocity (m/s)
Acetaldehyde	C ₂ H ₄ O	252.8
Acetylene	C ₂ H ₂	340.8
Ammonia	NH ₃	429.9
Argon	Ar	319.1
Benzene	C ₆ H ₆	183.4
Carbon dioxide	CO ₂	268.3
Carbon monoxide	CO	349.2
Carbon tetrachloride	CCl ₄	150.2
Chlorine	Cl ₂	212.7
Dimethyl ether	CH ₃ OCH ₃	213.4
Ethane	C ₂ H ₆	327.4
Ethanol	C ₂ H ₃ OH	267.3

Gases		Sound Velocity (m/s)
Ethylene	C ₂ H ₄	329.4
Helium	He	994.5
Hydrogen sulphide	H ₂ S	321.1
Methane	CH ₄	445.5
Methanol	CH ₃ OH	347
Neon	Ne	449.6
Nitrogen	N ₂	349.1
Nitrogen monoxide	NO	346
Oxygen	O ₂	328.6
Propane N.A.	C ₃ H ₈	246.5
Sulphur hexafluoride	SF ₆	137.8

13. Technical Data

Measuring principle:	Ultrasonic, echo time measurement
Measuring range:	NUS-4x04 0.20-4 m liquids, 0.2-1.6 m solids NUS-4x06 0.25-6 m liquids, 0.25-2.4 m solids NUS-4x08 0.35-8 m liquids, 0.5-3.2 m solids NUS-4x10 0.35-10 m liquids, 0.35-4 m solids NUS-4x15 0.45-15 m liquids, 0.45-6 m solids NUS-4x25 0.60-25 m liquids, 0.6-10 m solids
Frequency:	NUS-4x04 80 kHz NUS-4x06 80 kHz NUS-4x08 60 kHz NUS-4x10 60 kHz NUS-4x15 40 kHz NUS-4x25: 20 kHz
Measuring accuracy (at 20 °C):	± 0.2 % of measured value + 0.05 % of F.S.
Resolution:	depends on measuring distance < 2 m : 1 mm 2..5 m: 2 mm 6..10 m: 5 mm >10 m: 10 mm
Installation:	perpendicular to product surface
Process temperature:	-30...+90 °C
Ambient temperature:	-30..+70 °C -25..+70 °C (with programming unit)
Operating pressure:	0.5..3 bar abs. (for use <1 bar abs contact Kobold)
Housing:	Aluminium, powder coated
Sensor and connection:	Polypropylene, PVDF
Process connection:	NUS-4x04: G 1 1/2*, 1 1/2 NPT NUS-4x06, NUS-4008: G 2*, 2 NPT NUS-4x10: Flange DN 80, ANSI 3" NUS-4x15: Flange DN 100, ANSI 5" NUS-4x25: Flange DN 150, ANSI 6" *G-thread with nut and EPDM-gasket
Electrical connection:	2x M20x1,5 cable gland, cable dia. 6...12 mm and 2 x 1/2" NPT for cable gland; wire cross section: 0.5 ... 1.5 mm ²
Switching output:	Relay (SPDT) 30 V _{DC} , 1 A
Analogue output:	4...20 mA (3.9 ... 20.5 mA), galvanically isolated, protection against surge transients
Load:	max. (U _s – 11.4 V) / 0.02 A,
Supply voltage:	12...36 V _{DC} , 2-wire (reverse polarity protected)
Display (pluggable):	6-digit LCD, symbols and bar graph
Protection:	Sensor IP 68, Housing: IP 67

NUS-4

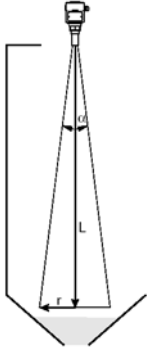
Conical beam diameter (r)							
L	NUS-4x04	NUS-4x06	NUS-4x08	NUS-4x10	NUS-4x15	NUS-4x25	
1	0.15 m	0.14 m	0.18 m	0.16 m	0.21 m	0.27 m	
2	0.25 m	0.23 m	0.30 m	0.25 m	0.30 m	0.39 m	
4	0.46 m	0.40 m	0.54 m	0.42 m	0.47 m	0.64 m	
6	-	0.58 m	0.79 m	0.60 m	0.65 m	0.88 m	
8	-	-	1,03 m	0.77 m	0.82 m	1.13 m	
10	-	-	-	0.95 m	1.00 m	1.37 m	
15	-	-	-	-	1.43 m	1.98 m	
25	-	-	-	-	-	3.21 m	
α	6°	5°	7°	5°	5°	7°	

14. Order Codes

Example: NUS-4004 R8 340

Model	Sensor material	Measuring range	Connection	Supply voltage	Output/display
NUS-4	0= Poly-propylene 9= PVDF	04= 0.2-4 m liquids 0.2-1.6 m solids	R8= G 1 1/2 N8= 1 1/2 NPT	3 = 12-36 V _{DC}	40= 4-20 mA R0=4-20 mA and Relay 4P=pluggable programming unit with LCD-Display, 4-20 mA RP= pluggable programming unit with LCD-Display, 4-20 mA, Relay
		06= 0.25-6 m liquids 0.25-2.4 m solids	R9= G 2 N9= 2 NPT		
		08= 0.35-8 m liquids 0.5-3.2 m solids	R9= G 2 N9= 2 NPT		
		10= 0.35-10 m liquids 0.35-4 m solids	FB= Flange DN 80 AB= ANSI-Flange 3"		
		15= 0.45-15 m liquids 0.45-6 m solids	FD= Flange DN 125 AD= ANSI-Flange 5"		
		25= 0.6-25 m liquids 0.6-10 m solids	FE= Flange DN 150 AE= ANSI-Flange 6"		
NUS-400P	pluggable programming unit with LCD-Display				

15. Dimensions

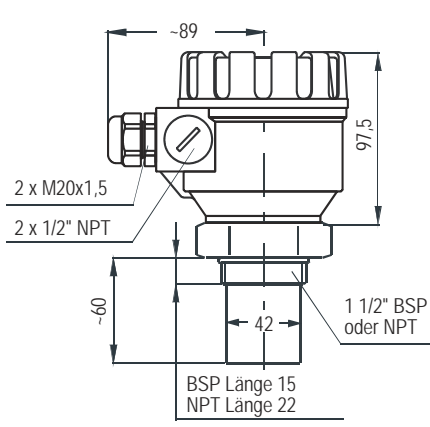
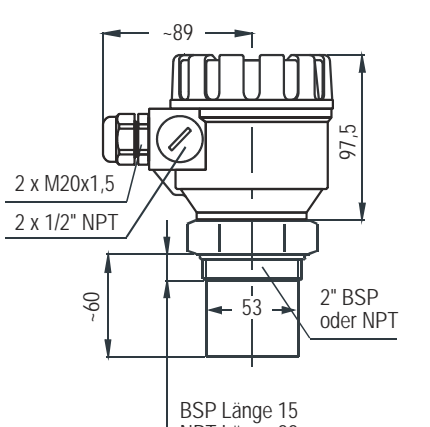
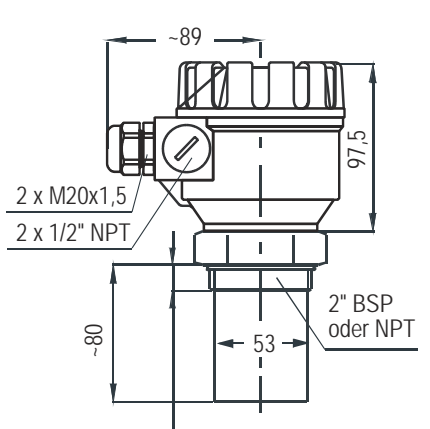
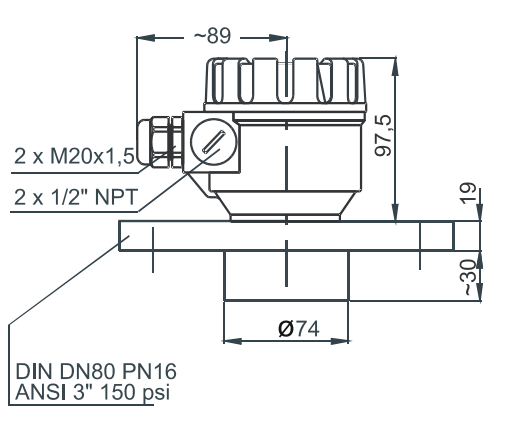
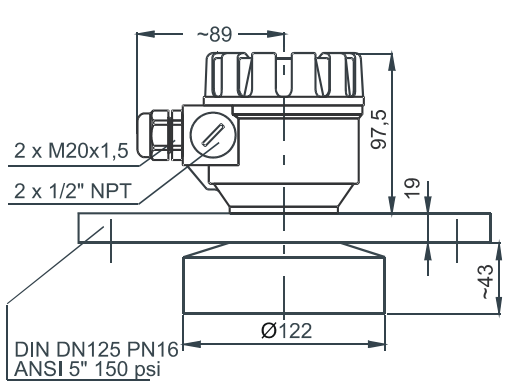
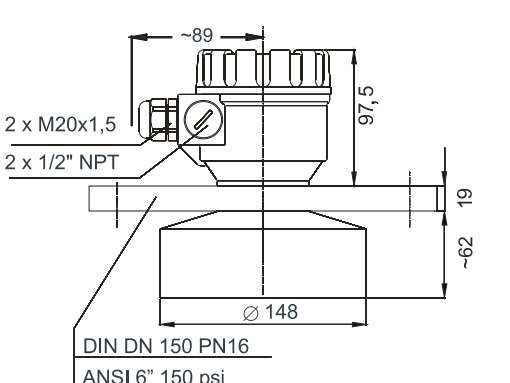
<p style="text-align: center;">NUS-4x04</p>  <p>2 x M20x1,5 2 x 1/2" NPT</p> <p>~89</p> <p>97,5</p> <p>~60</p> <p>42</p> <p>1 1/2" BSP oder NPT</p> <p>BSP Länge 15 NPT Länge 22</p>	<p style="text-align: center;">NUS-4x06</p>  <p>2 x M20x1,5 2 x 1/2" NPT</p> <p>~89</p> <p>97,5</p> <p>~60</p> <p>53</p> <p>2" BSP oder NPT</p> <p>BSP Länge 15 NPT Länge 22</p>
<p style="text-align: center;">NUS-4x08</p>  <p>2 x M20x1,5 2 x 1/2" NPT</p> <p>~89</p> <p>97,5</p> <p>~80</p> <p>53</p> <p>2" BSP oder NPT</p> <p>BSP Länge 15 NPT Länge 22</p>	<p style="text-align: center;">NUS-4x10</p>  <p>2 x M20x1,5 2 x 1/2" NPT</p> <p>~89</p> <p>97,5</p> <p>19</p> <p>~30</p> <p>Ø74</p> <p>DIN DN80 PN16 ANSI 3" 150 psi</p>
<p style="text-align: center;">NUS-4x15</p>  <p>2 x M20x1,5 2 x 1/2" NPT</p> <p>~89</p> <p>97,5</p> <p>19</p> <p>~43</p> <p>Ø122</p> <p>DIN DN125 PN16 ANSI 5" 150 psi</p>	<p style="text-align: center;">NUS-4x25</p>  <p>2 x M20x1,5 2 x 1/2" NPT</p> <p>~89</p> <p>97,5</p> <p>19</p> <p>~62</p> <p>Ø148</p> <p>DIN DN 150 PN16 ANSI 6" 150 psi</p>

16. EU Declaration of Conformance

We, KOBOLD Messring GmbH, Hofheim-Ts, Germany, declare under our sole responsibility that the product:

Ultrasonic Level Meter Model: NUS-...

to which this declaration relates is in conformity with the standards noted below:

EN 61010-1:2011 Safety requirements for electrical equipment for measurement, control and laboratory use - Part 1: General requirements

EN 61326-1:2013 Electrical equipment for measurement, control and laboratory use - EMC requirements - Part 1: General requirements

EN 61326-2-3:2013 Electrical equipment for measurement, control and laboratory use - EMC requirements - Part 2-3: Particular requirements - Test configuration, operational conditions and performance criteria for transducers with integrated or remote signal conditioning

Also the following EC guidelines are fulfilled:

2014/30/EU	EMC Directive
2014/35/EU	Low Voltage Directive
2011/65/EU	RoHS (category 9)



Hofheim, 12. July 2016

H. Peters
General Manager

M. Wenzel
Proxy Holder